

**SOLAR  
INNOVATION  
FOR THE 21ST  
CENTURY**

**ROBUST FOR  
ALL THE UK  
WEATHER CAN  
THROW AT IT**

**BRITISH DESIGN**

**BRITISH  
MANUFACTURE**

**BRITISH QUALITY**

**SEAMLESS  
SOLAR FOR  
SENSITIVE  
AESTHETICS**

[www.gb-sol.co.uk](http://www.gb-sol.co.uk)  
[slate@gb-sol.co.uk](mailto:slate@gb-sol.co.uk)  
01443 841 811  
Pontypridd, UK

**PV SLATE**



# Installation Guide

**GB-Sol** 

## Installation Notes

Please read these instructions in full before attempting an installation.

We provide free installation advice and training at our premises, contact us for more details.

Ensure any ladder leaning on the PV Slates is padded.

Store PV Slates in a clean, dry location.

PV Slates are a glass product. In particular avoid striking/placing weight on the corner of the glazed area. Avoid any corner contact with the ground when handling.

PV Slates are never installed in electrical strings of more than 77. Always observe the maximum system voltage of 600V.

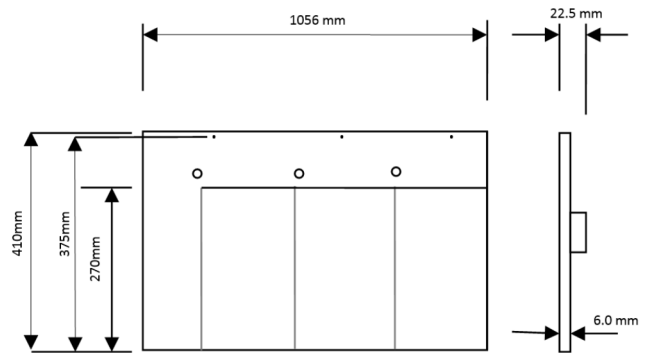

## Danger of Electrocutation

In daylight, PV Slates are always live. When 2 or more PV Slates are connected there is a danger of a DC shock. Work on DC systems should only be carried out by suitably qualified persons.



## Essential Roof Requirements

Ridge: 1 x Complete natural slate course + Top course of natural slates

Verge/Any Obstruction: 1 x Complete natural slate course

Gutter: 2 x Natural slate courses

Natural Slate Compatibility: 600mm x 300mm x 6mm (24 x 12 inch) - Blue-Grey.

Roof Pitch:







27.5° - 90° - Compatible

22° - 27.5° - Compatible with fully waterproof membrane

0° - 22° - Not Compatible



## Components List

		
<p>PV Slate Hooks</p>	<p>Roof Hooks</p>	<p>Right Hand Side Flashing</p>
		
<p>Wood Screws</p>	<p>Top Flashing</p>	<p>PV Slate</p>



## 1. Layout Roof Battens

The PV Slate requires a margin (visible area) of 265mm.

Set out the battens at a 265mm gauge.



Fit double battens on the batten above any natural slate.

Fit this double/extra batten on the lower side of the batten.

If preferred, double batten throughout.



The purpose of this double/extra batten is to support the top of the natural slate.



Note: It is possible to layout the battens in areas that contain only natural slates without the need for a double batten.

Always ensure a margin of 265mm is maintained.

## 2. Install Natural Slate Rows, up to but not Including the Natural Slate Row Below the PV Slates

Following standard roofing practice, install the required rows of natural slates from the gutter, stopping with one natural slate row required below the PV Slates.

Ensure a 3mm gap between natural slates.



## 3. Cut Natural Slates to Allow PV Slate Junction Box Clearance

Some natural slates on the natural slate row below the PV Slates need to be cut to allow the junction box on the back of the PV Slate to sit correctly.

This is achieved by cutting the top right hand corner of every third natural slate in this row.

We recommend temporarily placing the PV Slate above the cut natural slate into position to check the first cut-out is correct for your installation.



## 4. Install the Natural Slate Row Below the PV Slates with Roof Hooks

While installing the natural slate row beneath the PV Slates, nail the provided Roof Hooks into the batten.

This Roof Hook will support the bottom edge of the bottom row of PV Slates.

We recommend using a line of sealant around the "L" of the cut natural slates.



You may find it helpful to place the natural slates indicated (right) without fully nailing in place yet.

This will make locating the PV Slate cables easier during Step 6. The natural slates can then be nailed in.



### 5. Assemble PV Slates

Insert the provided PV Slate Hooks into the rubber grommets on the PV Slates before their installation.



### 6. Place First PV Slate into Position

Starting on the right of the bottom row of PV Slates, place the first PV Slate into position by locating the bottom edge into the nailed in Roof Hooks.

DO NOT fix yet.

Locate the cables for the electrical connection. Make sure the PV Slate junction box fits into your cut out.



### 7. Install Right Hand Side Flashing

Slide Right Hand Side flashing so that half of it is under the right edge of the first PV Slate and nail flashing into position.



### 8. Fix First PV Slate

Using the provided screws, screw the first PV Slate into the batten using the three holes along the top edge of the PV Slate.



### 9. Place Second PV Slate into position

Slide the second PV Slate over the built-in left hand side flashing of the installed PV Slate and locate in Roofing Hooks.

Ensure you make the electrical connection while doing this.



### 10. Fix Second PV Slate

Leaving a 3mm gap between the glazed areas of the two PV Slates, screw into position.



### 11. Complete First PV Slate Row

Repeat steps 9 &10 to complete the first row, ensuring all electrical connections are made.

We recommend electrically testing the installed PV Slates at the end of each row.



### 13. Install Natural Slates at Ends of Row

We recommend alternate natural slate and a halves on each row.

You will notice the top of the natural slate will rest on the double batten above.



#### 14. Repeat Procedure to Install Remaining PV Slate Rows

Complete all the rows of PV Slates, ensuring all electrical connections are made.



#### 15. Install Top Flashing

Position the Top Flashings above the top row of glass or as specified by our drawing.

Overlap the Top Flashings by 100mm and ensure the Top Flashing protrudes the PV Slate glazing at the ends of the row by a minimum of 150mm.

Nail into place.

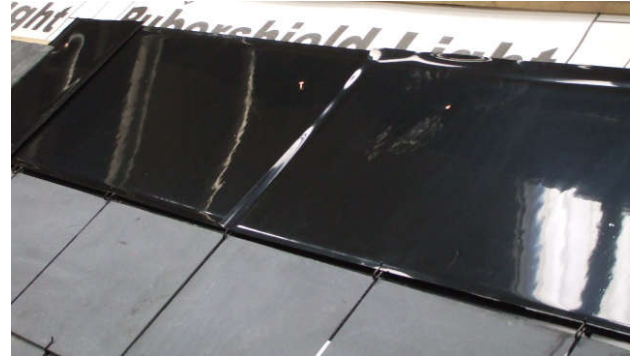

#### 16. Complete Roof

The remainder of the roof can now be slated as per standard roofing practice.

We recommend cleaning the PV Slates with a soft cloth and water to remove any dust created from the installation.



# 35WP

## PER PV SLATE

# 10

## HIDDEN MONO-CRYSTALLINE CELLS PER PV SLATE

### Roofing & Mechanical Data:

PV Slates/Roof Area	Approx 4 PV Slates per m <sup>2</sup> (4.19)
Dimensions (L x W x D)	Nominal - 1056mm x 410mm x 6mm Visible - 906mm x 265mm x 6mm (Replaces 3 Natural Slates)
PV Slate Holing Gauge	375mm (Base of PV Slate to fixing hole)
Slate Weight (Individual Product)	3.5 Kg
Minimum Natural Slates on Roof	Ridge: 1 x Complete natural slate course + Top course of natural slates Verge/Any Obstruction: 1 x Complete natural slate course Gutter: 2 x Natural slate courses
Natural Slate Size Compatibility	600mm x 300mm x 6mm (24 x 12 inch)
Natural Slate Colour Compatibility	All blue-grey slates (La Concha best match)
Batten Gauge	265mm
Roof Pitch	27.5° - 90° - Compatible 22° - 27.5° - Compatible with waterproof membrane 0° - 22° - Not Compatible
Roof Mounting Method (Supplied)	3 of M5 x 25mm A2 pan-head wood screws 3 of Roof Hooks 2.7mm 316 Steel grey powder coated

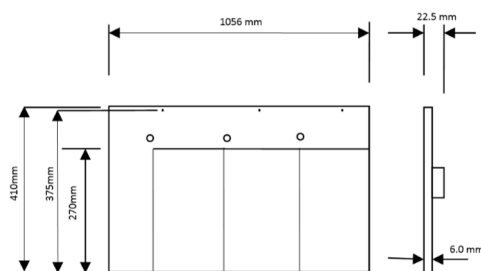

### General Data:

Packaging	60 PV Slates / Box on Oversized Pallet Box: 1700mm (L) x 1150 mm (W) x 550 mm (H) plus pallet Packed Weight 230 Kg (excluding pallet)
Connectors	MC4 with 1.0m fly leads
Feed in Tariff Applicable	No
Self Cleaning	Yes
Other colours available	Black (Contemporary)
Product Warranty	10 Years
Power Output Warranty	10 Years

### Electrical Data:

Nominal Output (P <sub>max</sub> , MPP)	35 Wp (+/-10%)
Short Circuit Current - I <sub>sc</sub>	6.63 A
Open Circuit Voltage - V <sub>oc</sub>	6.67 V
MPP Current	6.31 A
MPP Voltage	5.55 V
Temperature Coefficient of Power	-0.40 % /K
Temperature Coefficient of Voltage - V <sub>oc</sub>	-0.32 % /K
Temperature Coefficient of Current - I <sub>sc</sub>	0.042 % /K
Maximum Permissible System Voltage	600 V

www.gb-sol.co.uk  
slate@gb-sol.co.uk  
01443 841 811  
Pontypridd, UK



# GB-Sol